

Frühstücks- und Lesetisch

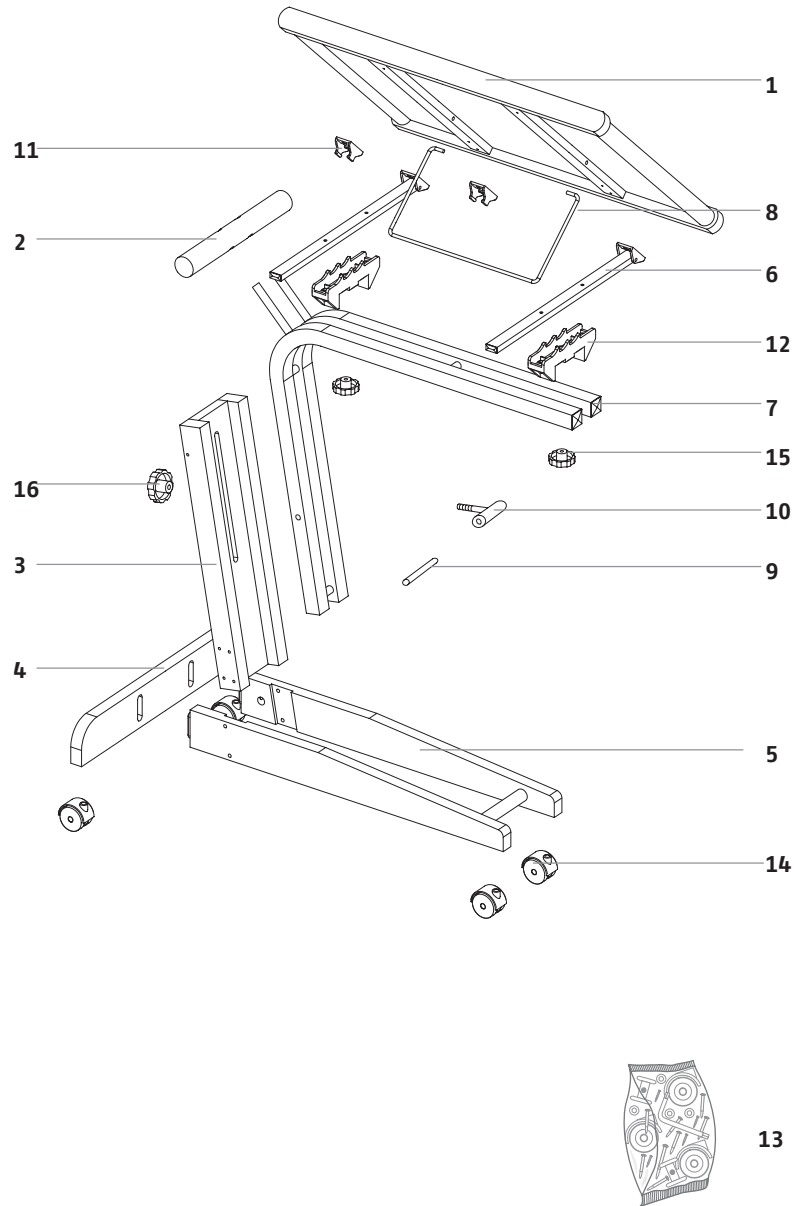

Montage- und Gebrauchsanweisung

Lesen Sie diese sorgfältig und heben Sie sie für eine spätere Verwendung auf!

Warnung

- Kontrollieren Sie regelmäßig die Befestigung aller Komponenten.
- Prüfen Sie vor der Benutzung Ihres Frühstücks- und Lesetisches, ob er richtig montiert ist.
- Reinigen Sie den Tisch mit Reinigungsmittel (keine Lösungsmittel) und trocknen Sie ihn danach gründlich ab.
- Achtung! Stellen Sie keine heißen Gegenstände auf die Ablageflächen.
- Maximale Traglast ist 20 kg.

Assembly and operating instructions

Read carefully and keep for future reference!

Warning

- Regularly check that all components are perfectly fastened.
- Before using your breakfast and reading table, check that it is properly assembled.
- Clean using a damp cloth or a sensitive cleaning agent (no solvents) and dry thoroughly.
- Warning! Do not place any hot objects on the shelves.
- The maximum load is 20 kg.

Bestandteile



A 1 x



B 2 x



C 2 x



D 2 x

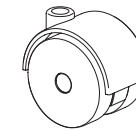

E 4 x

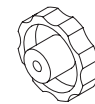

F 2 x



G 4 x

- Rahmen aus Buchenholz
- Kunststoffteile aus Nylon
- Räder aus Nylon
- Oberteil: beschichtete Holzfaser

- Frame made of beech wood
- Nylon plastic parts
- Nylon wheels
- Top part: Coated wood fibre

Montage/Assembling

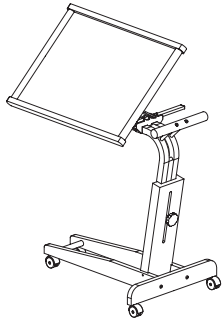
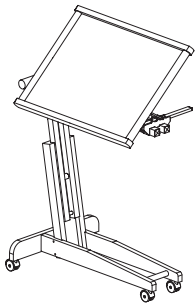
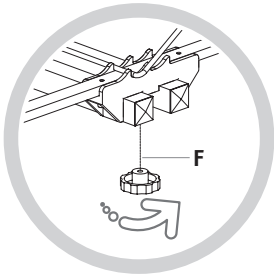
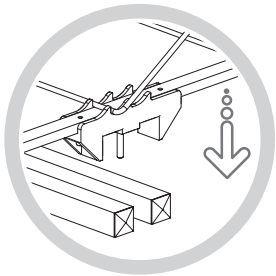
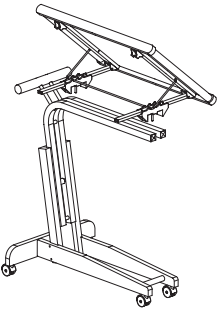
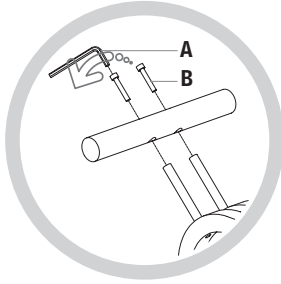
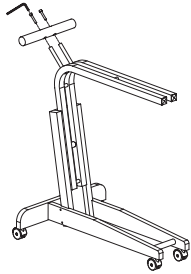
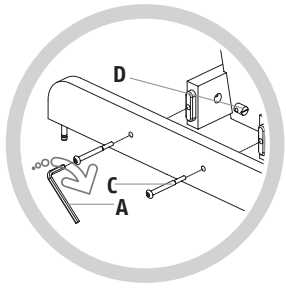
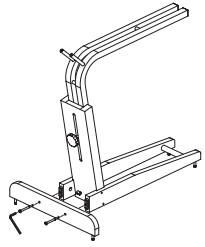

Bedienungsanweisung/Operating instructions

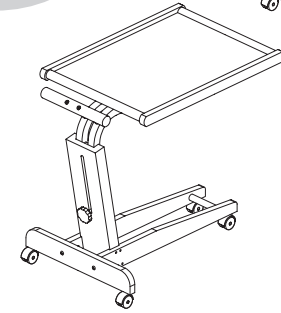
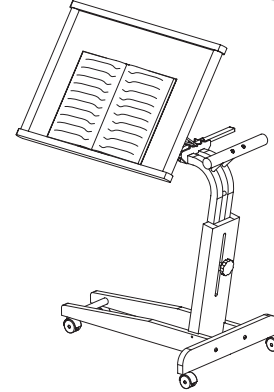
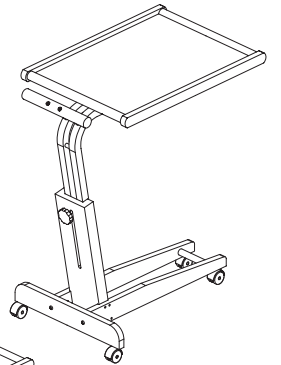
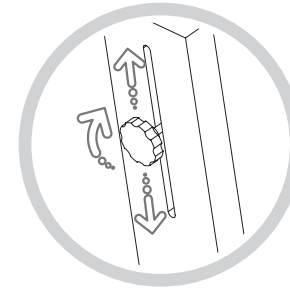
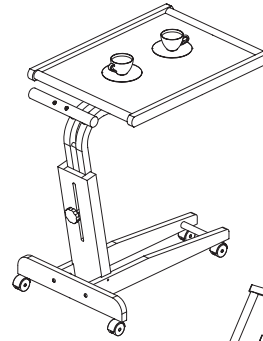

öffnen/open

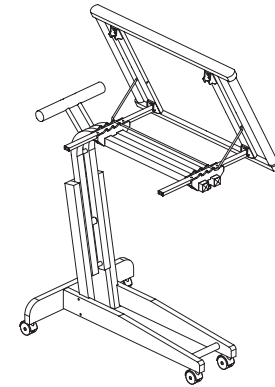
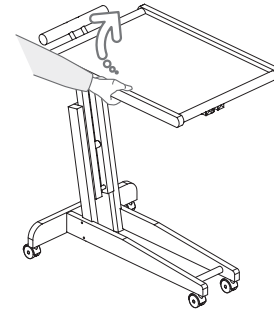

geschlossen/closed

